



# MAKE YOUR OWN BEEP SPACE ROVER!



**Follow the instructions  
on each page to cut out  
and create your very own  
Beep Space Rover!**

**What you'll need:**

- Scissors
- Glue or Sticky Tape
- Cardboard (for leg support)

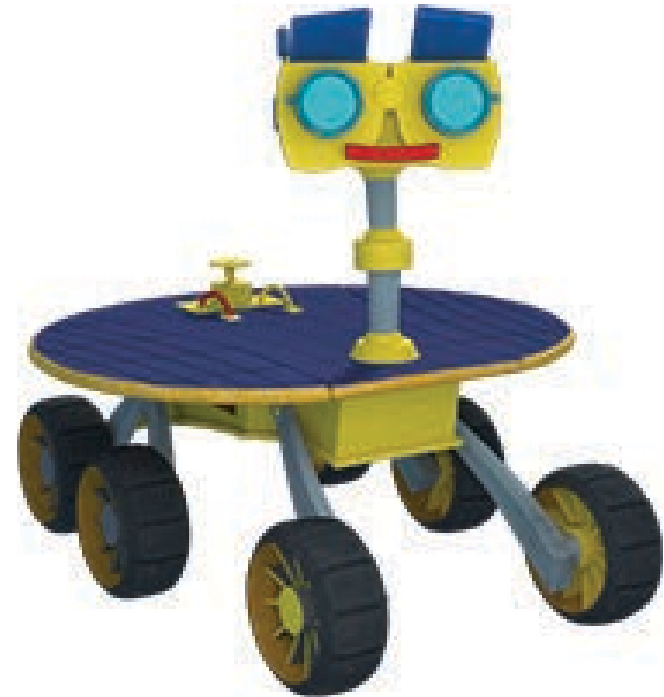

For more games and activities visit  
[pbskids.org/readyjetgo](https://pbskids.org/readyjetgo)

# Beep's Head

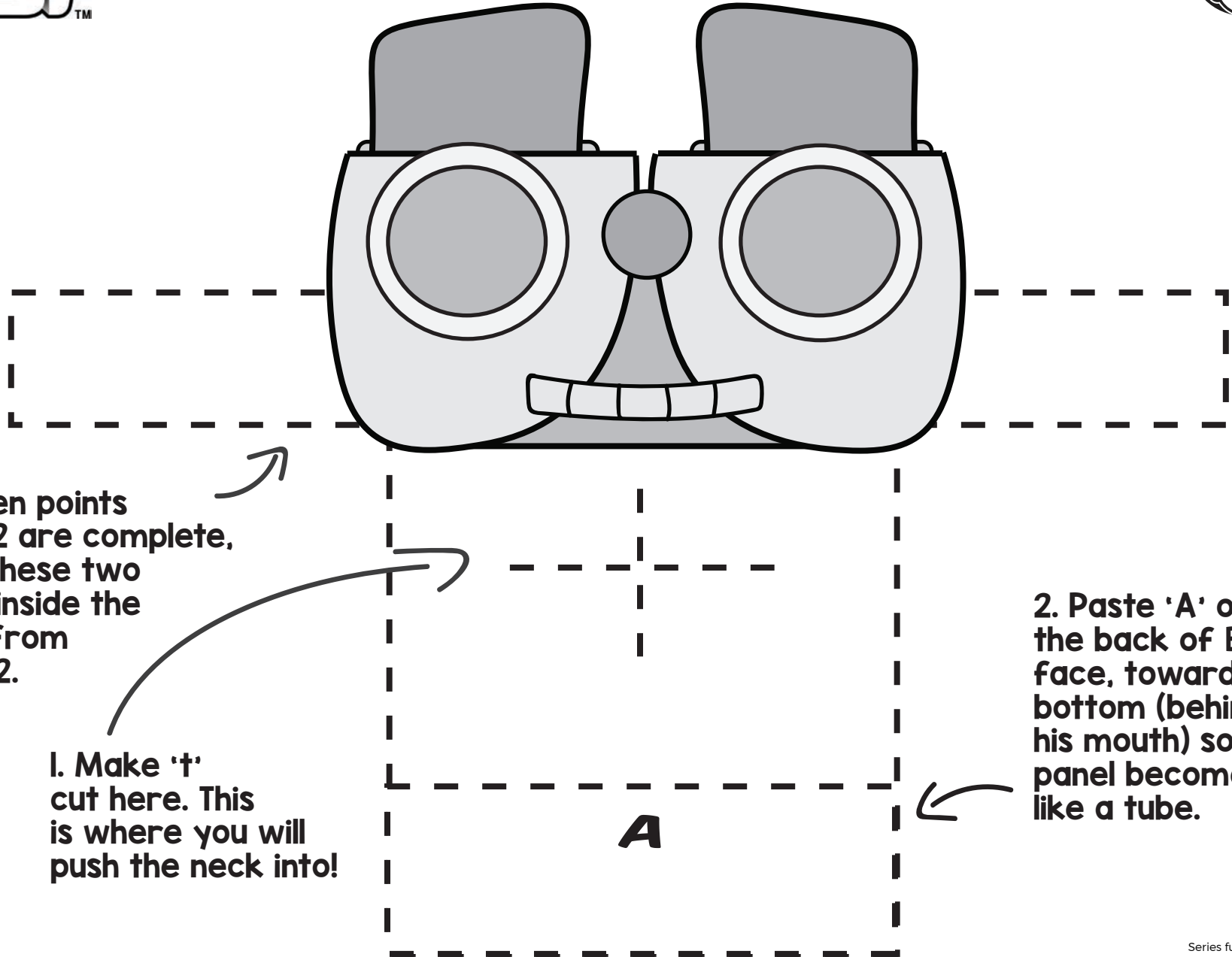

3. When points 1 and 2 are complete, tuck these two sides inside the tube from point 2.

1. Make '1' cut here. This is where you will push the neck into!

2. Paste 'A' on to the back of Beep's face, towards the bottom (behind his mouth) so this panel becomes like a tube.



# Beep's Neck

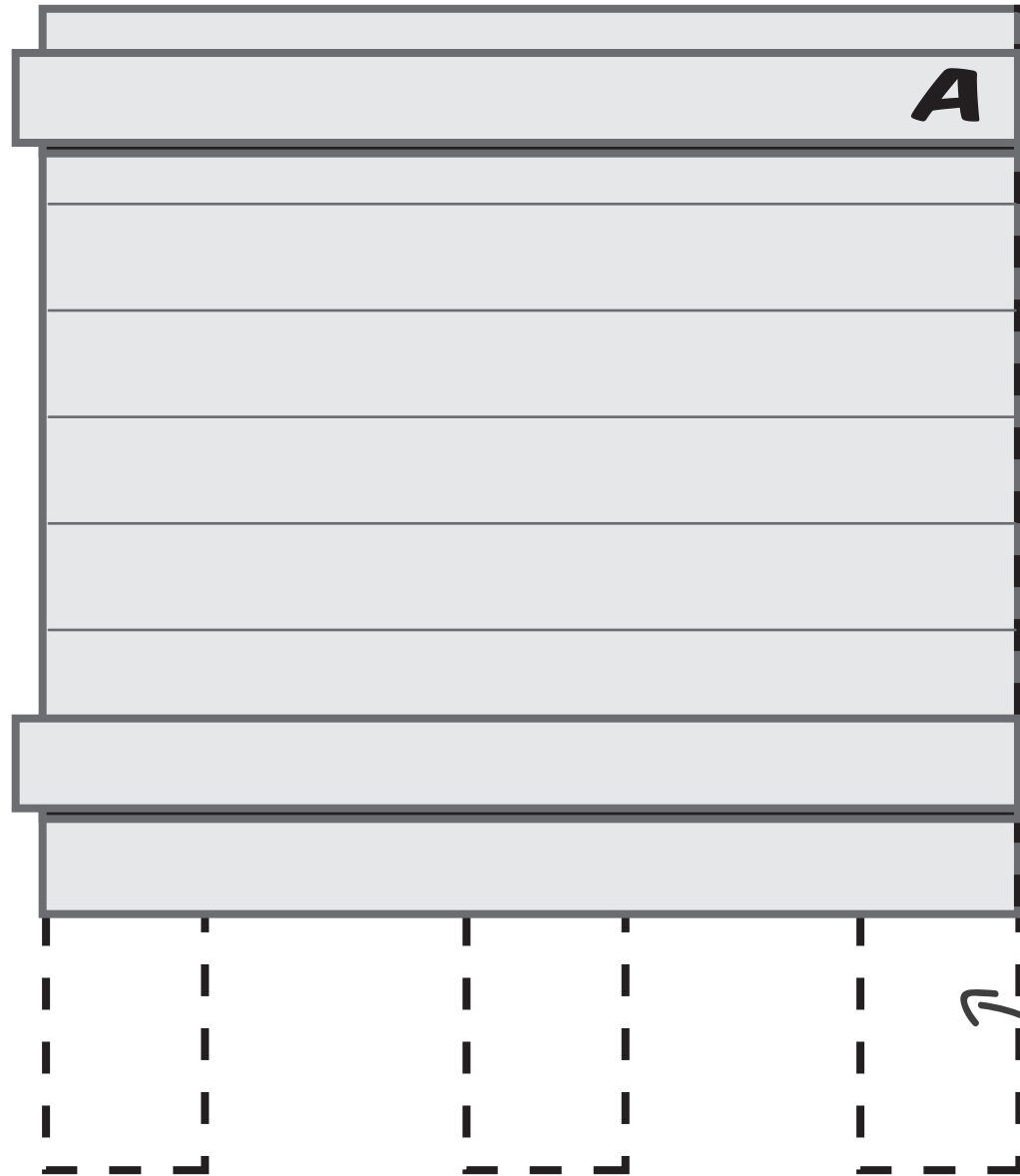

1. Roll this side first, then.

2. Fold and paste 'B' to stick together

3. Once complete you will stick the top of the neck in the 't' cut you made on Beep's head!

**B**

4. Once the neck is made, you'll push these through the cut out circle on beep's back.

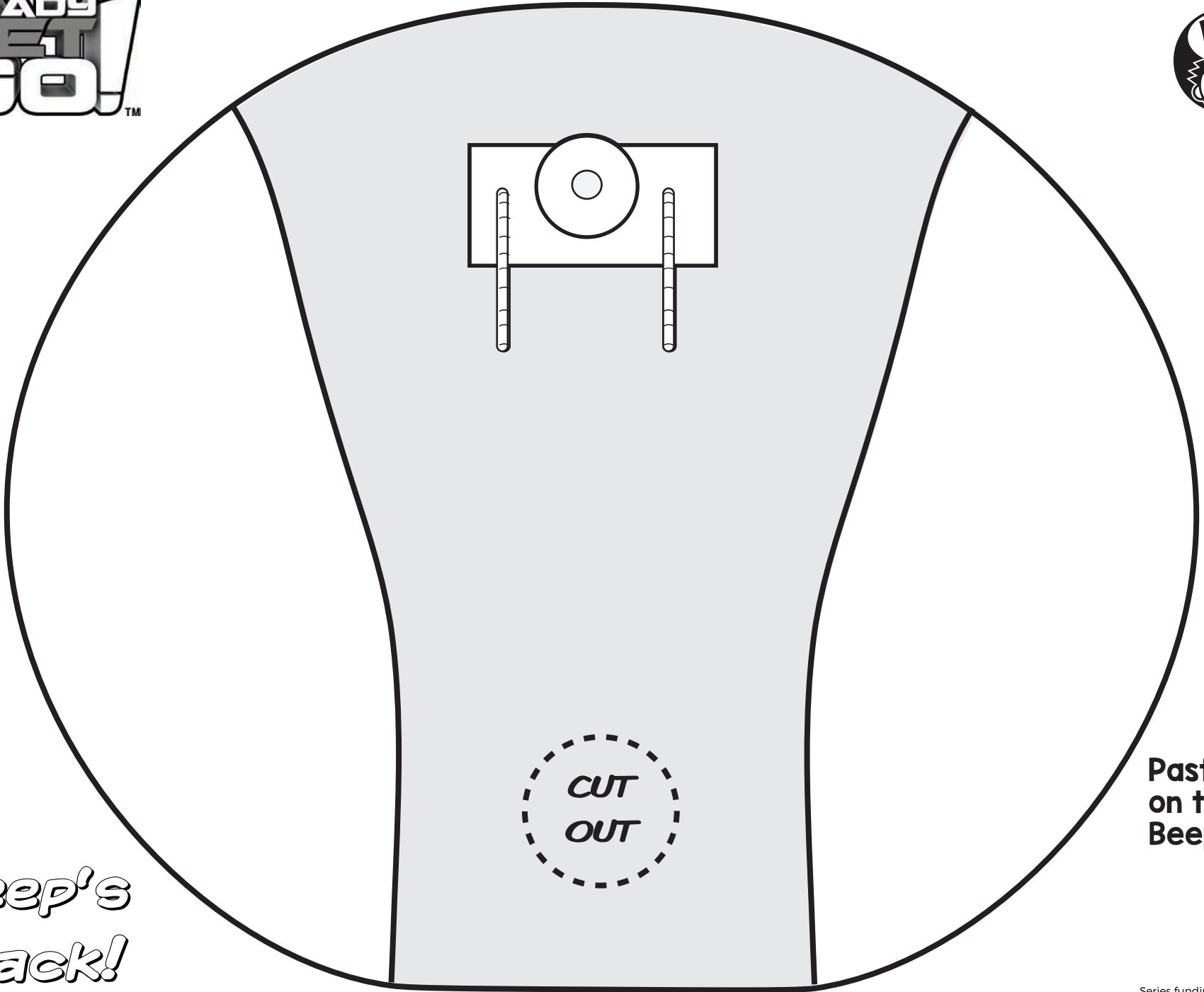

*Beep's  
Back!*

**Paste this  
on top of  
Beep's belly.**

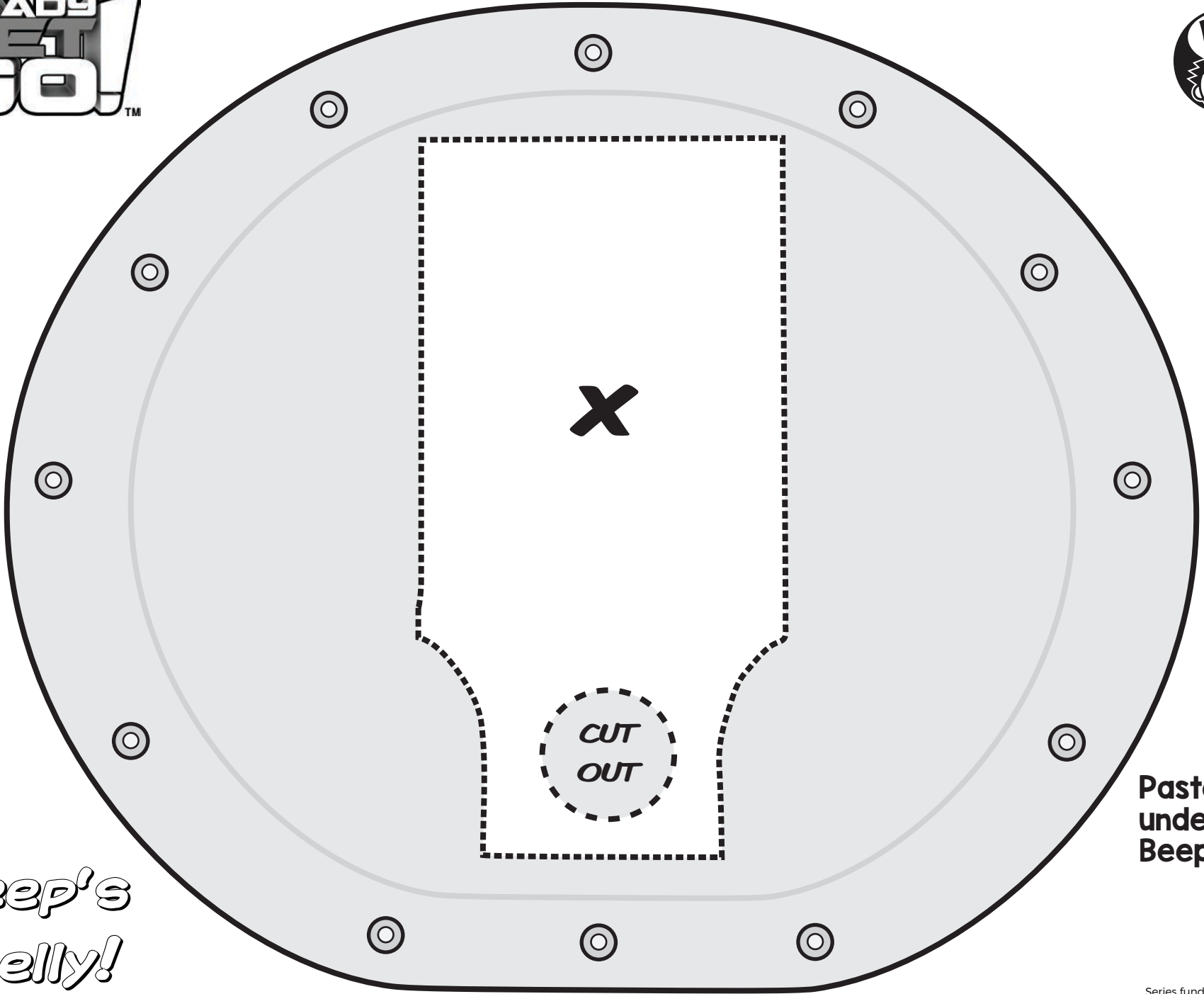

Paste this underneath Beep's back.

Beep's Belly!

WIND DANCER FILMS

© Public Broadcasting Service. All rights reserved. Copyright 2018 Jet Propulsion, LLC. Ready Jet Go! and A Kids Place Is Exploring Space are registered trademarks of Jet Propulsion, LLC.

Series funding provided by:

KUMON

ABCmouse.com

# Beep's Body

1. Fold and paste the pieces marked 'C' underneath the body.

2. Paste 'X' on to the 'X' on Beep's Belly!

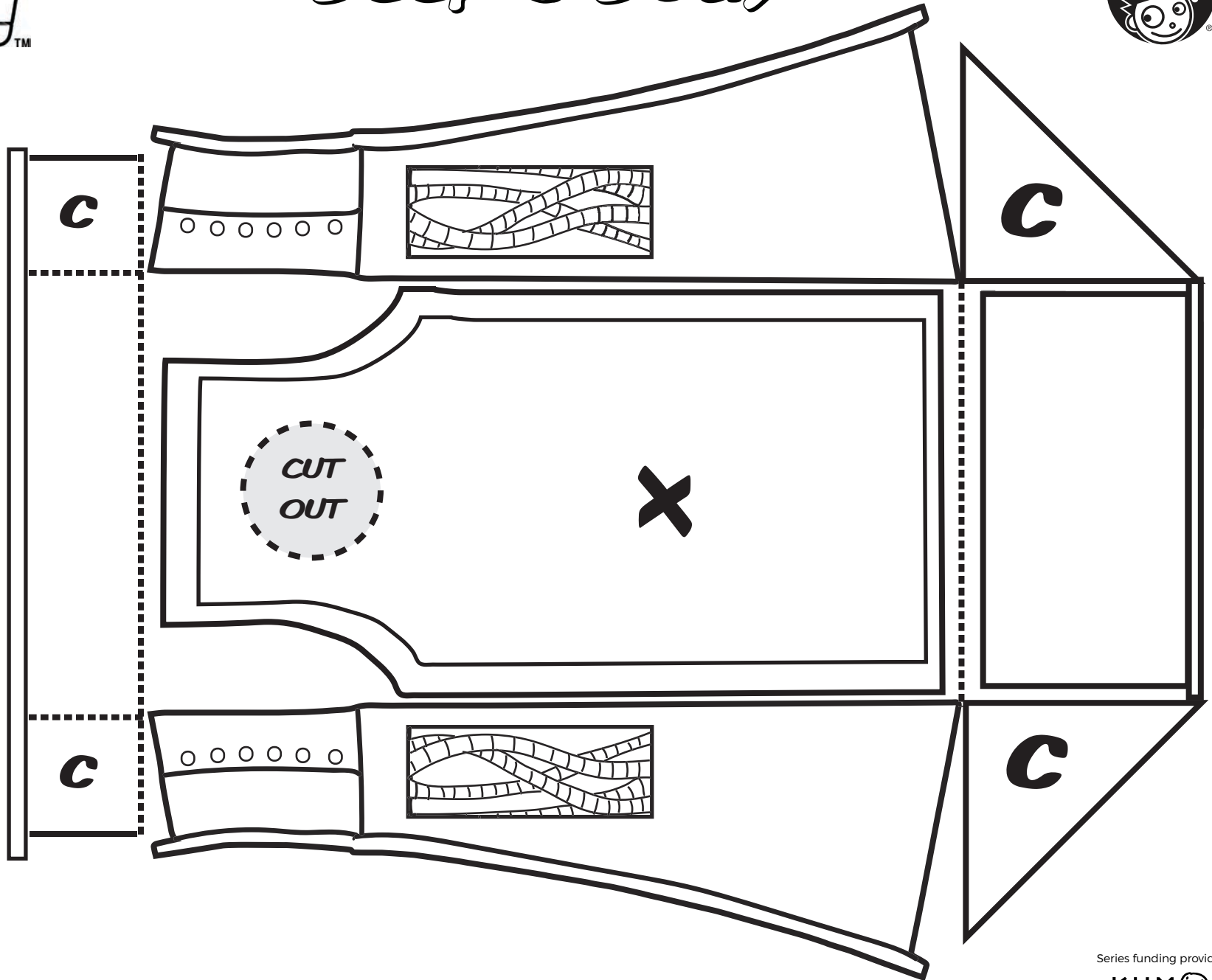

# Beep's Legs

1. Cut out the legs!

2. For support, grab some cardboard cut out in the same shape and paste behind the legs.

3. Paste base of legs to the back of the wheels.

4. Paste top of legs to the inside of the body.

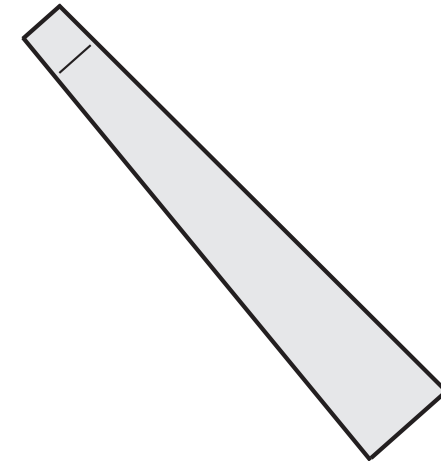
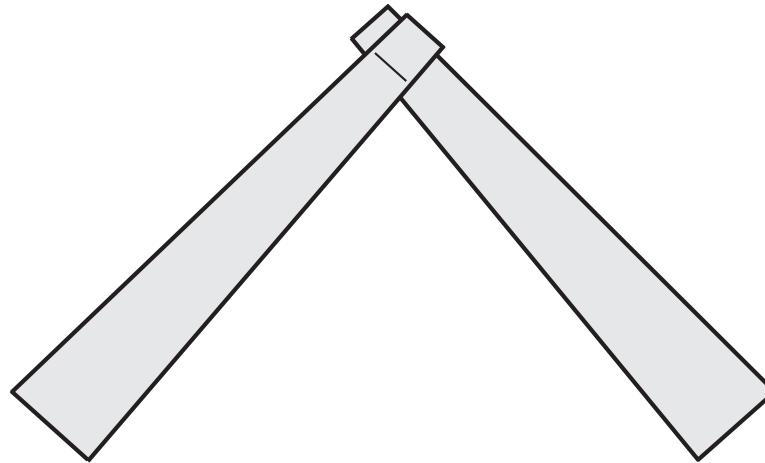
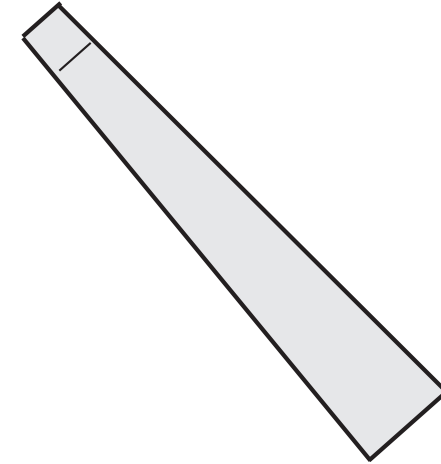
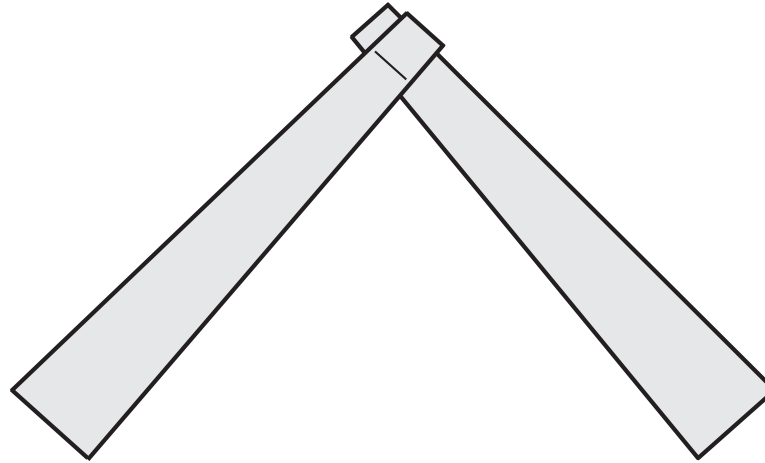

**BACK LEGS**

**FRONT LEGS**

# Beep's Wheels

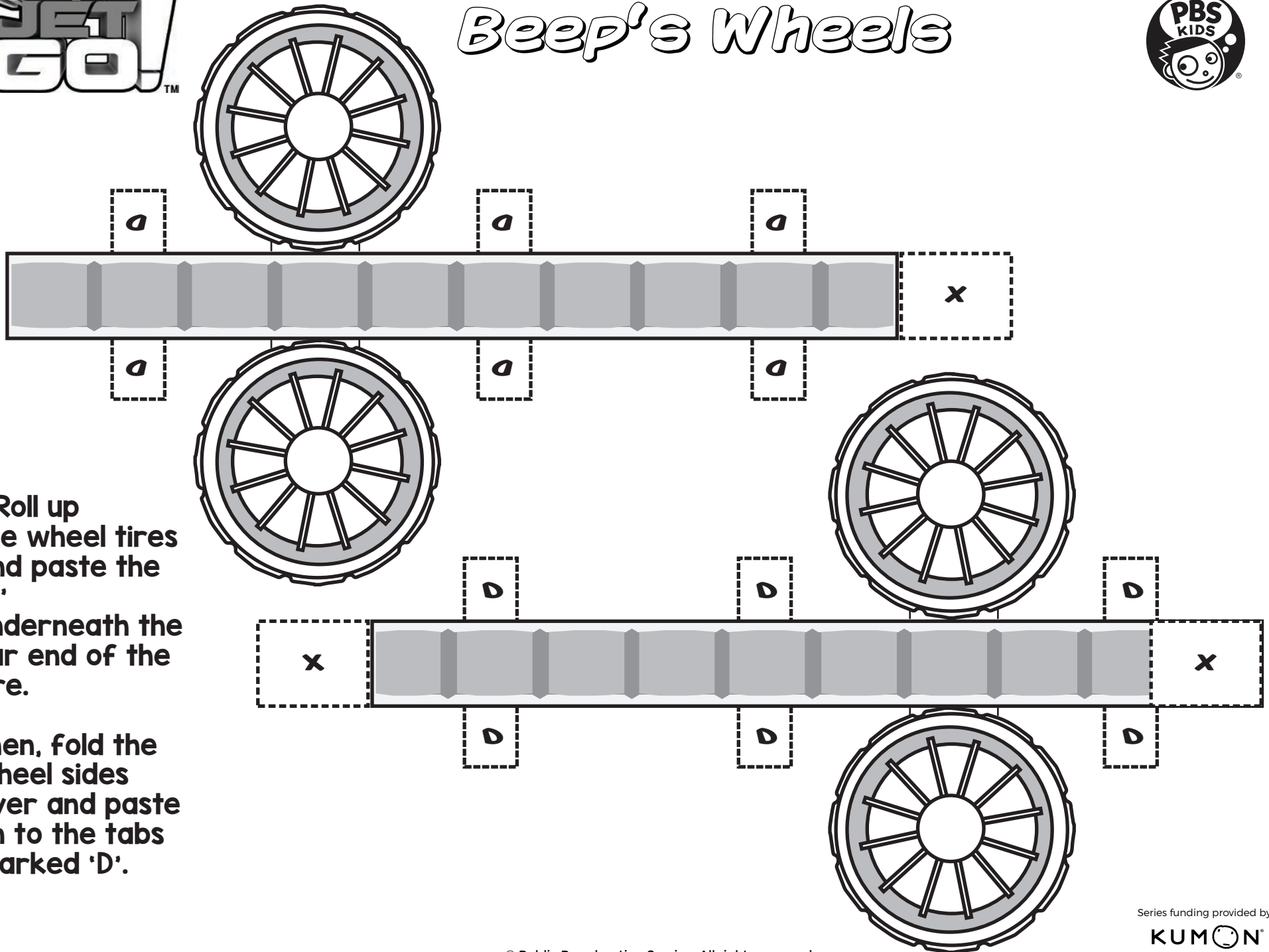

I. Roll up the wheel tires and paste the 'X' underneath the far end of the tire.

Then, fold the wheel sides over and paste on to the tabs marked 'D'.



# Beep's Wheels

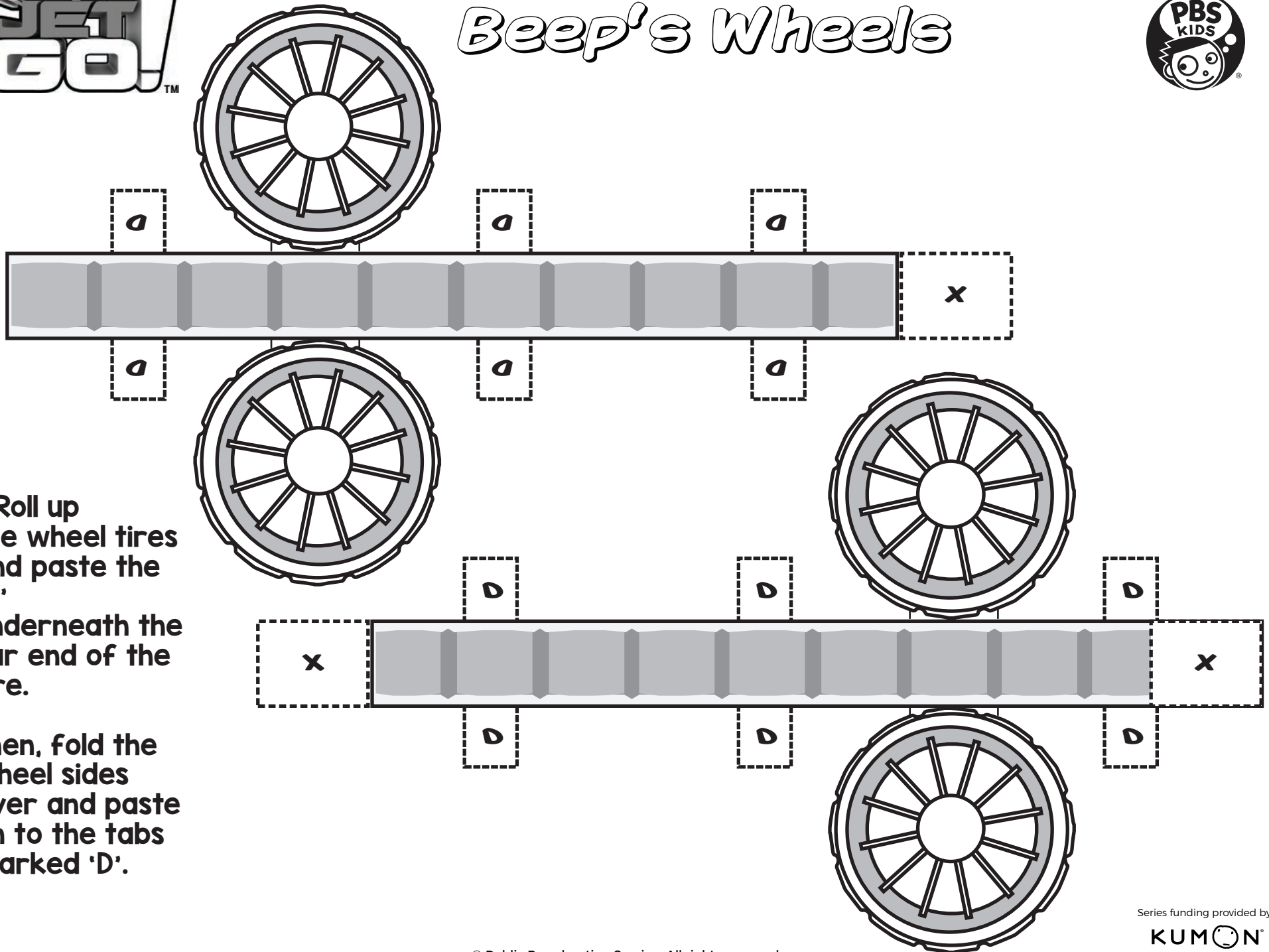

I. Roll up the wheel tires and paste the 'X' underneath the far end of the tire.

Then, fold the wheel sides over and paste on to the tabs marked 'D'.

# Beep's Wheels

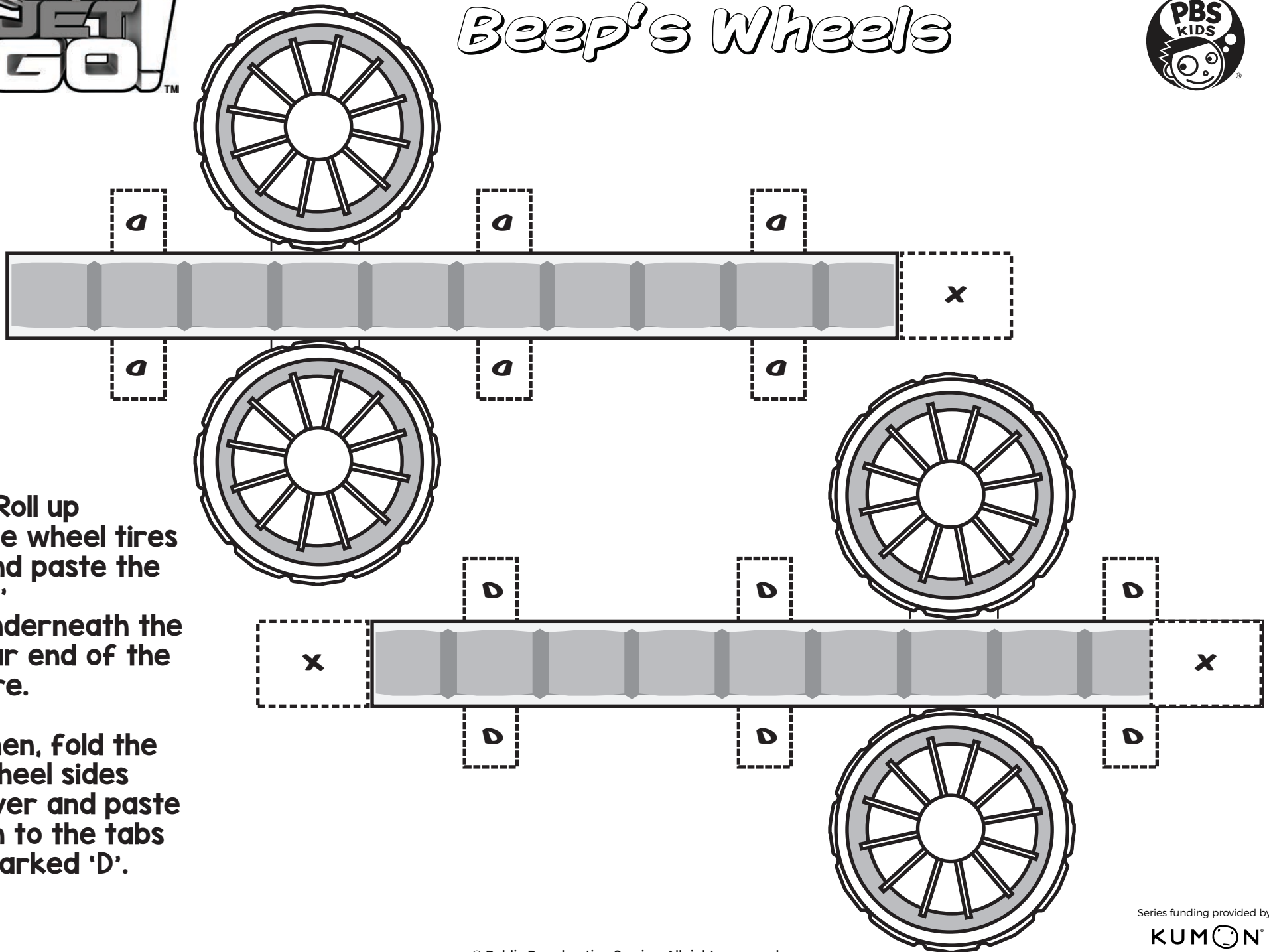

I. Roll up the wheel tires and paste the 'X' underneath the far end of the tire.

Then, fold the wheel sides over and paste on to the tabs marked 'D'.